

Outer Casing

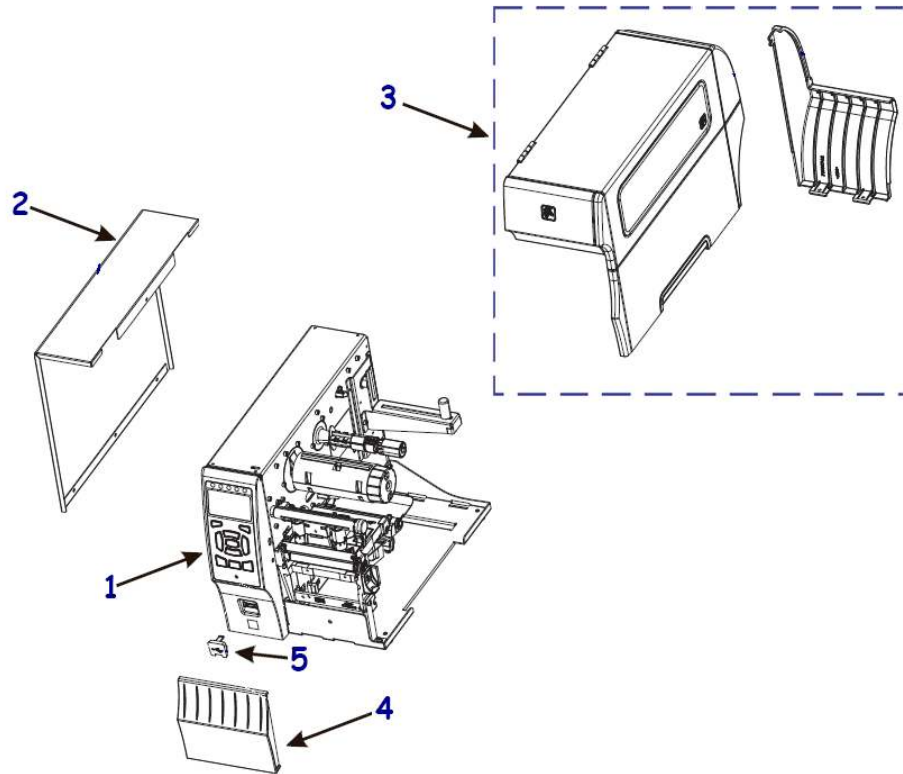

Item Number	Description	Part Number	Quantity
1	Color Control Panel ZT410. This item is for ZT410 printers that include the letter A in their part number: ZT410Ax-xxxxxxx	P1058930-400	1
1	Monochrome Control Panel ZT410. This item is for ZT410 printers that do NOT include the letter A in their part number: ZT4104x-xxxxxxx	P1058930-001	1
1	Color Control Panel ZT420. This item is for ZT420 printers that include the letter A in their part number: ZT420Ax-xxxxxxx	P1058930-401	1
1	Monochrome Control Panel ZT420. This item is for ZT420 printers that do NOT include the letter A in their part number: ZT4206x-xxxxxxx	P1058930-041	1
2	Electronics Cover ZT400 Series	P1058930-003	1
3	Media Cover (includes window) ZT410	P1058930-004	1
3	Media Cover (includes window) ZT420	P1058930-005	1
	Window for Media Cover ZT400 Series	P1058930-008	1
4	Front Lower Panels ZT410 (includes tear and peel panels)	P1058930-006	1
4	Front Lower Panels ZT420 (includes tear and peel panels)	P1058930-007	1
5	Cover for the dual port USB (Qty 3) ZT400 Series. This item is for ZT400 Series printers that include the letter A in their part number: ZT4xxAx-xxxxxxx	P1058930-404	3
5	Cover for the single port USB (Qty 3) ZT400 Series. This item is for ZT400 Series printers that do NOT include the letter A in their part number: ZT4xxx-xxxxxxx	P1058930-002	3

Print Mechanism

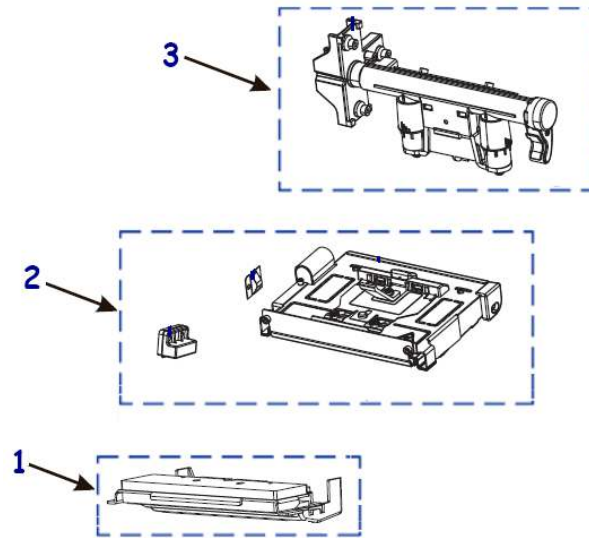

Item Number	Description	Part Number	Quantity
1	Printhead 203 dpi ZT410	P1058930-009	1
1	Printhead 300 dpi ZT410	P1058930-010	1
1	Printhead 600 dpi ZT410	P1058930-011	1
1	Printhead 203 dpi ZT420	P1058930-012	1
1	Printhead 300 dpi ZT420	P1058930-013	1
2	Thermal Transfer Print Mechanism ZT410 (includes ribbon sensor with cable, printhead cables, ground contact and magnets)	P1058930-016	1
2	Thermal Transfer Print Mechanism ZT420 (includes ribbon sensor with cable, printhead cables, ground contact and magnets)	P1058930-017	1
3	Toggle Bar (includes lift strap) ZT410	P1058930-018	1
3	Toggle Bar (includes lift strap) ZT420	P1058930-019	1
	Ribbon Strip Plate and Ribbon Static Brush ZT410	P1058930-094	1
	Ribbon Strip Plate and Ribbon Static Brush ZT420	P1058930-095	1
	Magnets for holding the Print Mechanism open	P1058930-082	1
	Ground Contact ZT400 Series	P1058930-083	1

Printhead dpi conversion

Item Number	Description	Part Number	Quantity
	Convert to 300 dpi ZT410	P1058930-022	1
	Convert to 203 dpi ZT410	P1058930-023	1
	Convert to 600 dpi ZT410	P1058930-024	1
	Convert to 300 dpi ZT420	P1058930-025	1
	Convert to 203 dpi ZT420	P1058930-026	1

Platen Roller

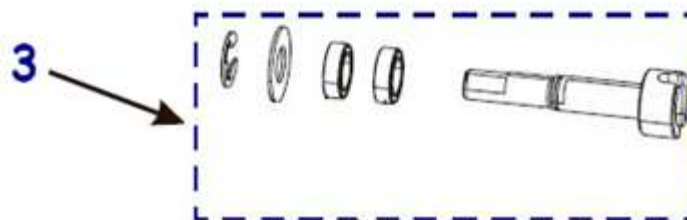
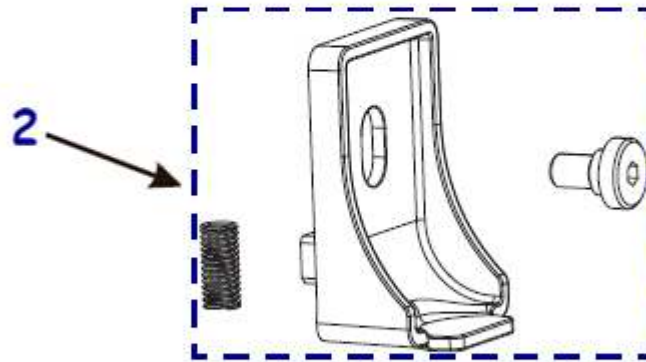
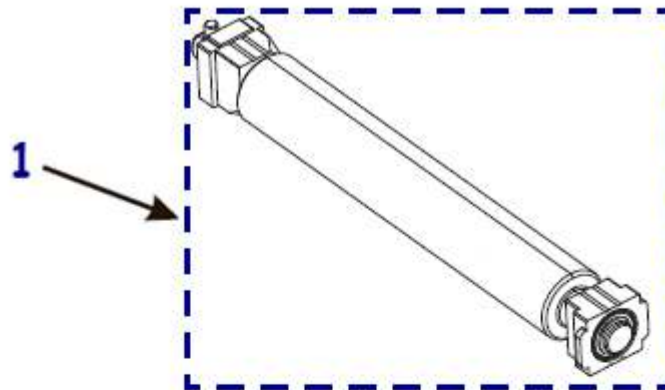

Item Number	Description	Part Number	Quantity
1	Platen Roller ZT410	P1058930-080	1
1	Platen Roller ZT420	P1058930-081	1
2	Lock/Retainer for the Platen Roller ZT400 Series	P1058930-027	1
3	Coupler for Platen Roller ZT400 Series	79862M	1

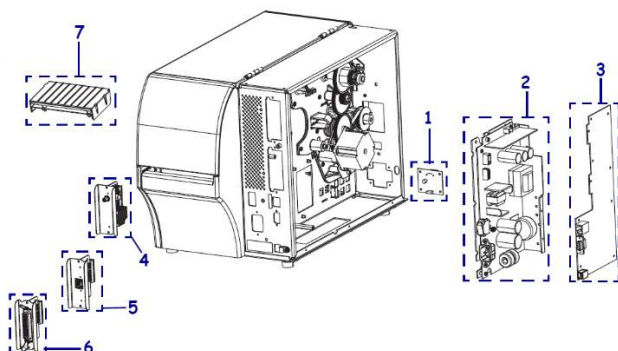
Electronics

Item Number	Description	Part Number	Quantity
1	Dual Port USB PCBA ZT400 Series. This item is for ZT400 Series printers that include the letter A in their part number: ZT4xxAx-xxxxxxx	P1058930-403	1
1	Single Port USB PCBA ZT400 Series. This item is for ZT400 Series printers that do NOT include the letter A in their part number: ZT4xxx-xxxxxxx	P1058930-029	1
2	Power Supply ZT400 Series	P1058930-032	1
3	Main Logic Board ZT400 Series	P1058930-402	1
	Mounting Bracket for the Main Logic Board ZT400 Series	P1058930-031	1
4	ZebraNet Internal Wireless 802.11 n radio ZT400 Series USA & Canada.	P1058930-097A	1
4	ZebraNet Internal Wireless 802.11 n radio ZT400 Series Japan.	P1058930-097B	1
4	ZebraNet Internal Wireless 802.11 n radio ZT400 Series for all countries except USA, Canada or Japan.	P1058930-097C	1
4	ZebraNet Internal Wireless 802.11 ac radio ZT400 Series USA & Canada. This item is only compatible with ZT400 Series printers using firmware version V75.20.14Z or later.	P1083320-037A	1
4	ZebraNet Internal Wireless 802.11 ac radio ZT400 Series Japan. This item is only compatible with ZT400 Series printers using firmware version V75.20.14Z or later.	P1083320-037B	1
4	ZebraNet Internal Wireless 802.11 ac radio ZT400 Series for all countries except USA, Canada or Japan. This item is only compatible with ZT400 Series printers using firmware version V75.20.14Z or later.	P1083320-037C	1
5	Internal Printserver (Ethernet port) ZT400 Series	P1058930-074	1
6	Parallel Port ZT400 Series	P1058930-075	1
7	RFID Module USA & Canada ZT400 Series	P1058930-500A	1
7	RFID Module Japan ZT400 Series	P1058930-500B	1
7	RFID Module Global (All countries except USA, Canada, Japan) ZT400 Series	P1058930-500C	1
	Replacement RFID Cables and Hardware ZT400 Series	P1058930-503	1
	Shutdown Power Module ZT400 Series	P1058930-033	1
	Light Assemblies (Includes 1 Print Mechanism Light & 1 Media Light)	P1058930-079	2
	Replacement Antenna for 802.11n & ac Radios	P1037974-053	1
	Electronics Cables ZT400 Series	P1058930-034	1
	USA Power Cord	46693	1
	Europe Power Cord	46629	1
	UK Power Cord	46637	1
	Japan Power Cord	37609	1
	China Power Cord	47612	1

Sensors

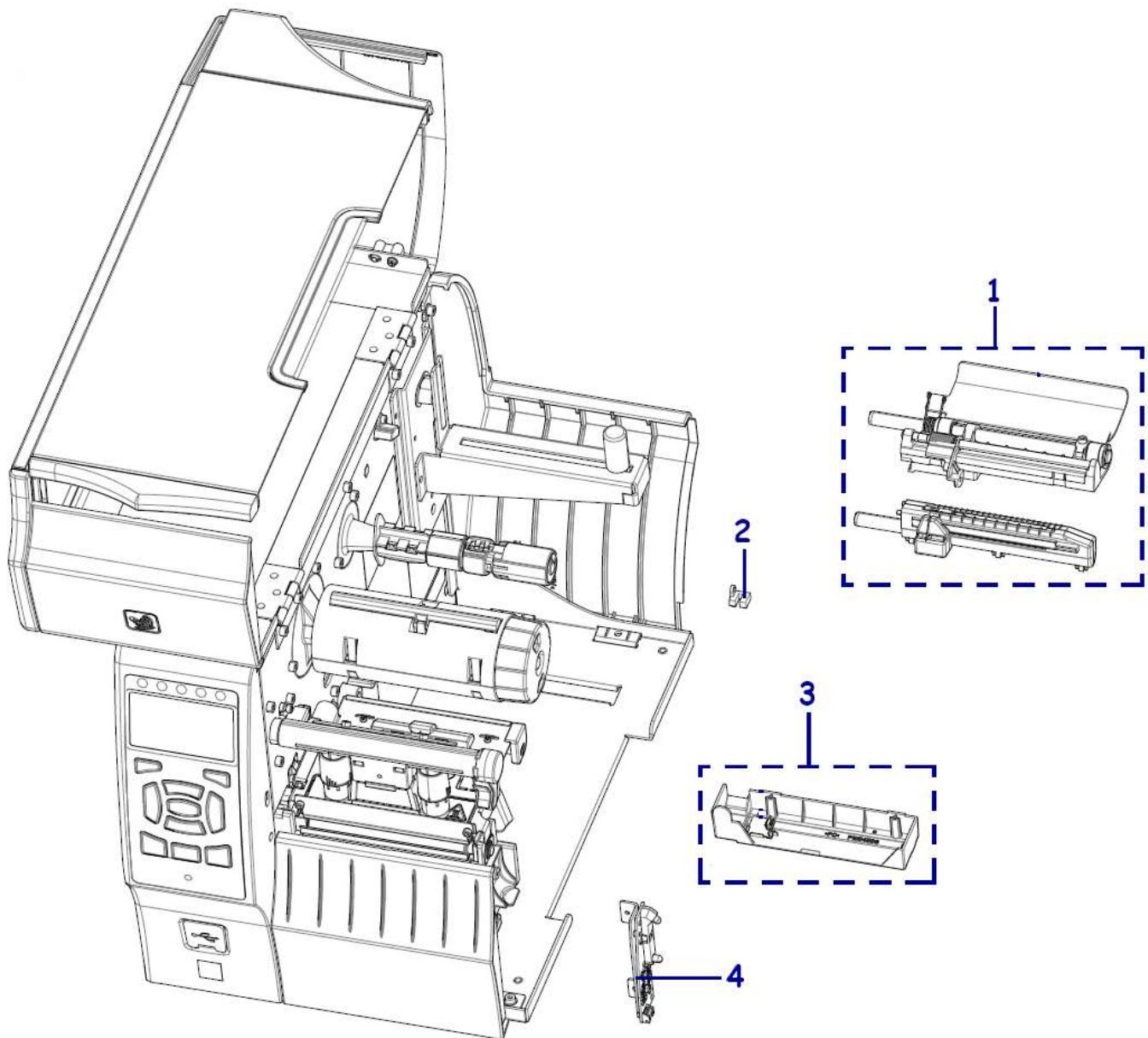

Item Number	Description	Part Number	Quantity
1	Media Sensor ZT410	P1058930-035	1
1	Media Sensor ZT420	P1058930-036	1
2	Head Open Sensor ZT400 Series	P1058930-084	1
3	Ribbon Sensor ZT410	P1058930-037	1
3	Ribbon Sensor ZT420	P1058930-038	1
4	Take Label Sensor ZT400 Series	P1058930-077	1

Drive System

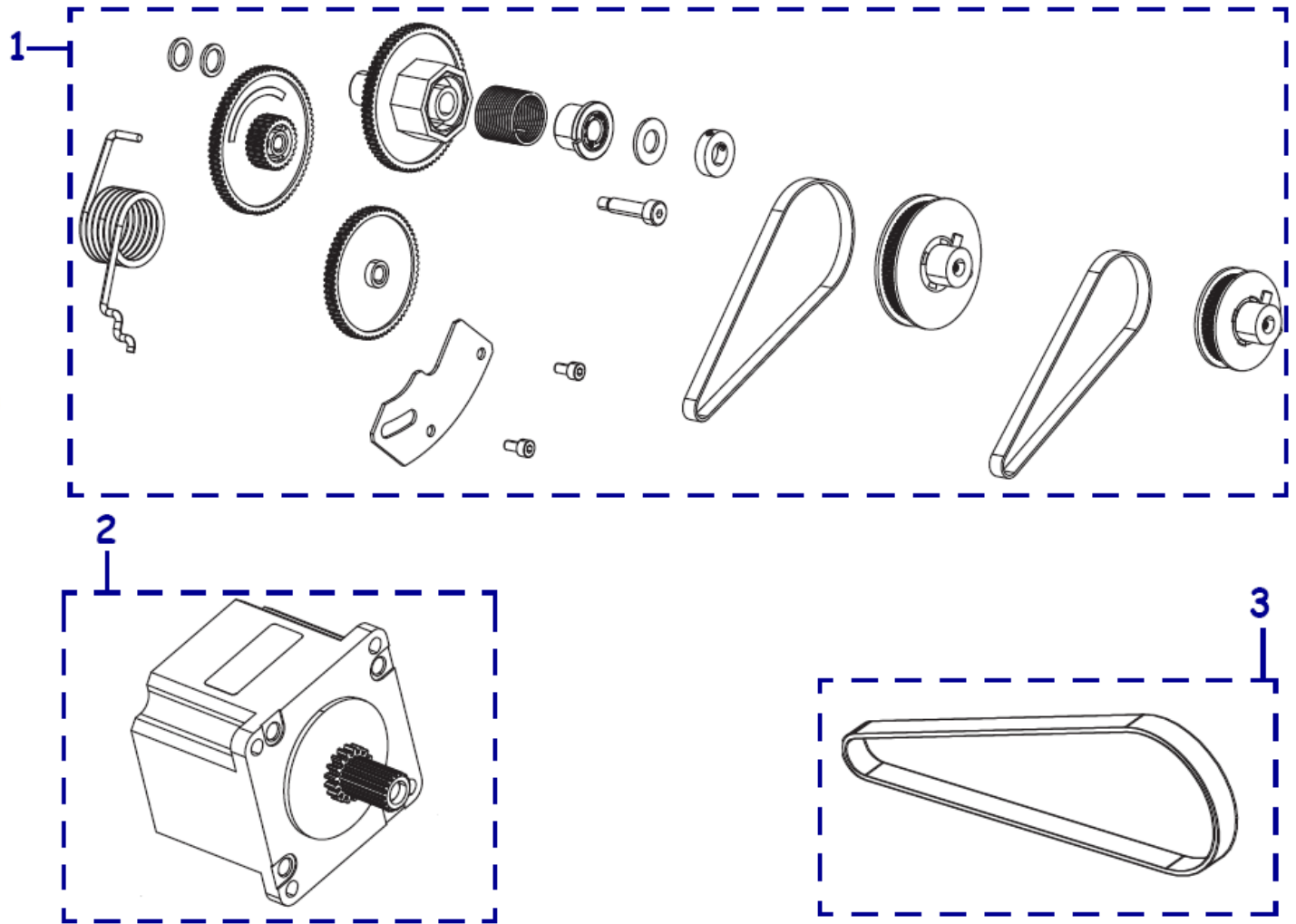

Item Number	Description	Part Number	Quantity
1	Drive System ZT400 Series (includes gears, belts and pulleys for 203 dpi and 300/600 dpi)	P1058930-039	1
2	Drive Motor ZT400 Series	P1058930-040	1
3	Drive Belt 203 dpi ZT400 Series	79866M	1
3	Drive Belt 300 dpi and 600 dpi ZT400 Series	79867M	1

Media Path

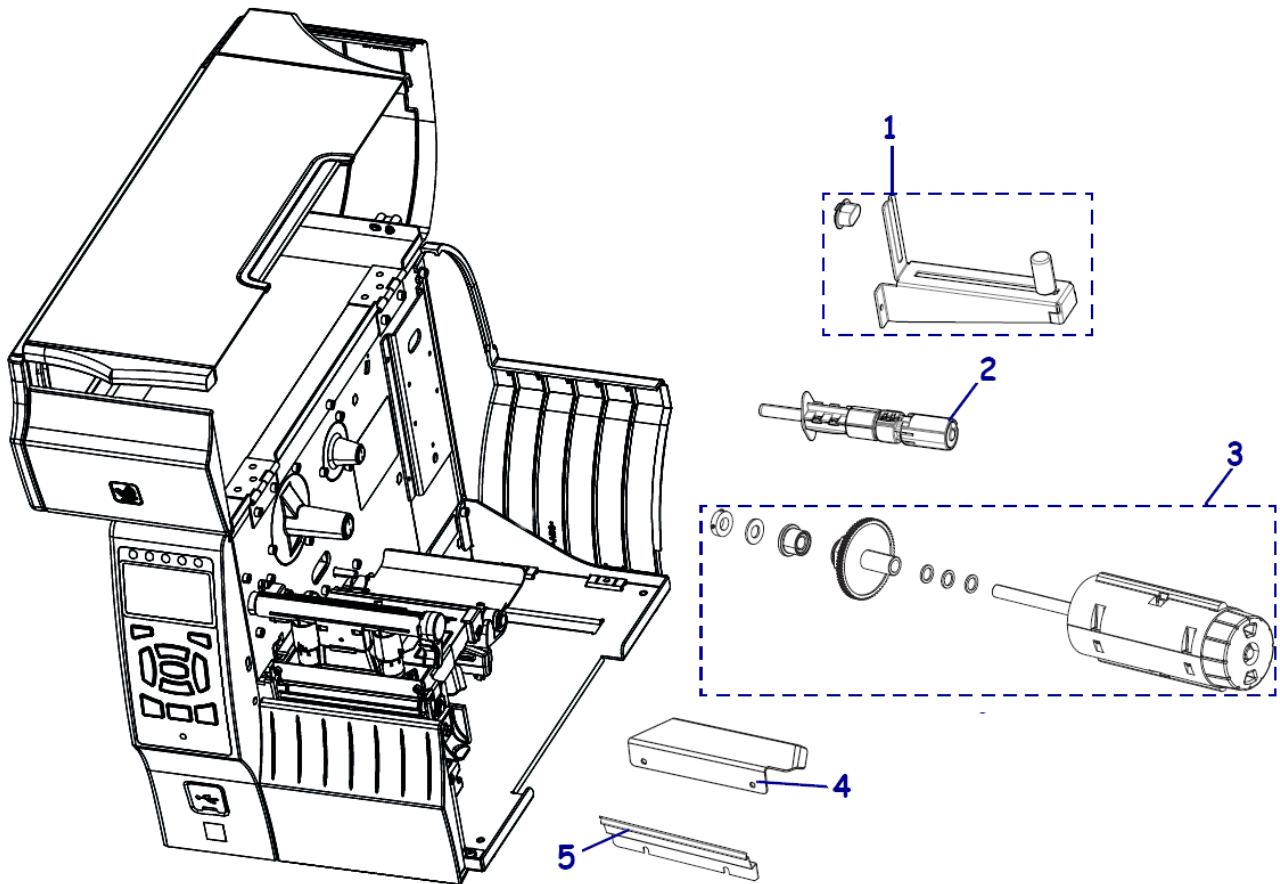

Item Number	Description	Part Number	Quantity
1	Standard Media Hanger for 3" (76mm) diameter media cores ZT410	P1058930-042	1
	Media Hanger for 1" (25mm) diameter media cores ZT410 only	P1058930-086	1
1	Standard Media Hanger ZT420	P1058930-043	1
2	Ribbon Supply Spindle ZT410	P1058930-085	1
2	Ribbon Supply Spindle: For Ribbons Coated Inside Only ZT410	79830M	1
2	Ribbon Supply Spindle ZT420	79829M	1
3	Ribbon Take Up Spindle ZT410	P1058930-045	1
3	Ribbon Take Up Spindle ZT420	P1058930-046	1
4	Media Shelf ZT410	P1058930-047	1
4	Media Shelf ZT420	P1058930-048	1
5	Tear Bar ZT410	79837M	1
5	Tear Bar ZT420	79838M	1

Field Installable Media Handling Options: Cutter - Peel - Liner Take Up

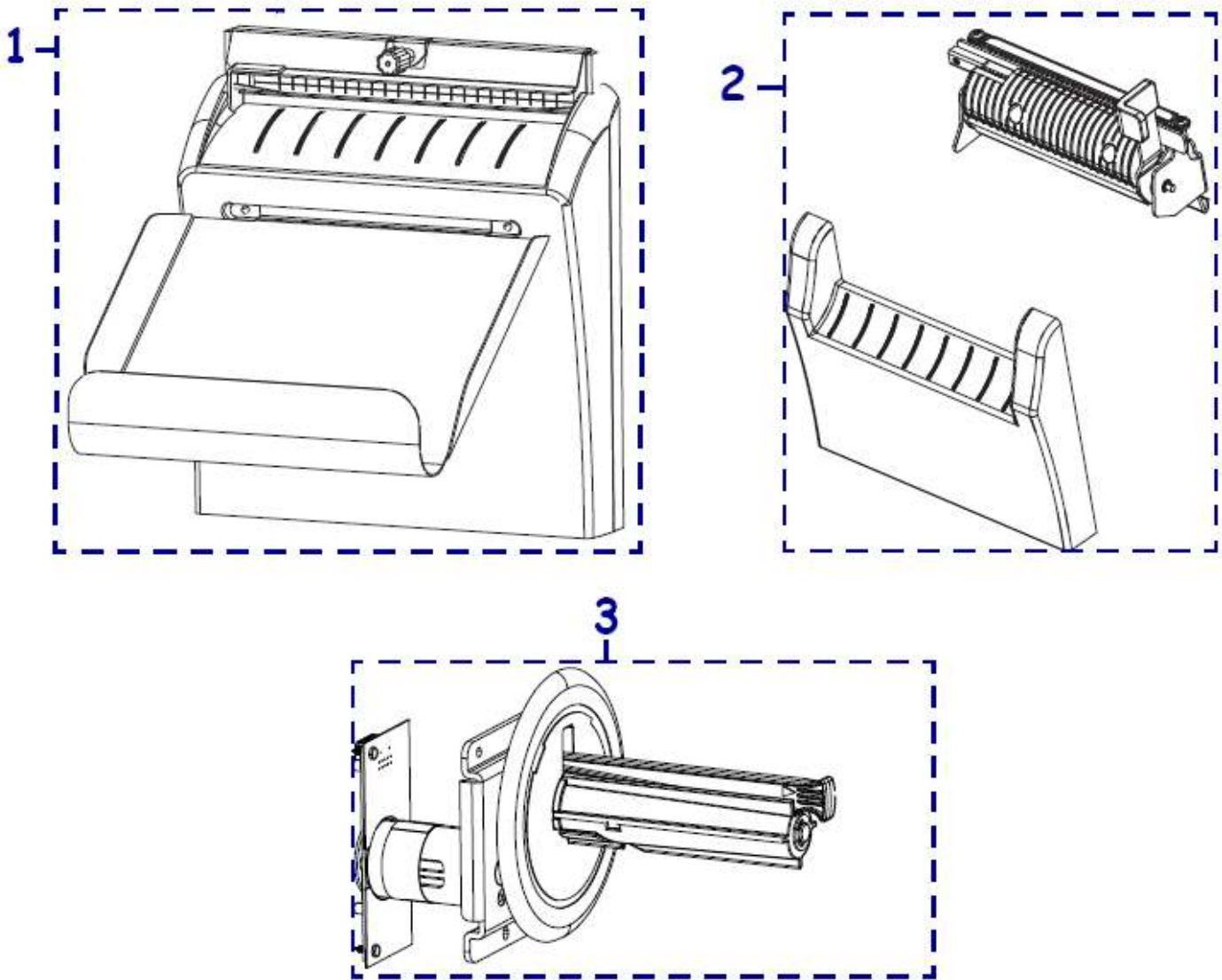

Item Number	Description	Part Number	Quantity
1	Cutter Option ZT410	P1058930-189	1
1	Cutter Option ZT420	P1058930-190	1
2	Peel Assembly ZT410	P1058930-098	1
2	Peel Assembly ZT420	P1058930-051	1
3	Liner Take Up Spindle & Motor ZT410 (To enable liner take up functionality, also order the P1058930-098 peel assembly)	P1058930-052	1

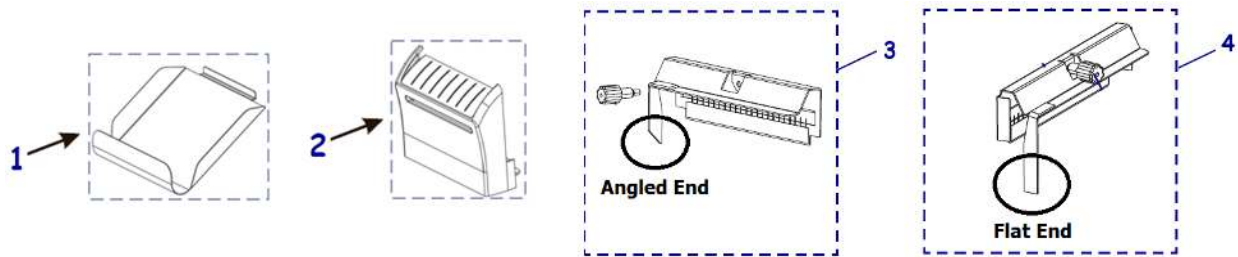
Cutter Replacement Parts

Item Number	Description	Part Number	Quantity
1	Catch Tray for Cutter ZT410	77041	1
1	Catch Tray for Cutter ZT420	77997	1
2	Cover for the Cutter includes PCBA and cutter cable ZT410. This item is only for replacing cutter PCBA part number P1059429-01 or cutter cover part number P1053981-1. The PCBA included in this kit is only compatible with the included flat end cutter guard.	P1058930-091	1
2	Cover for the Cutter includes PCBA and cutter cable ZT420. This item is only for replacing cutter PCBA part number P1059429-01 or cutter cover part number P1057226-1. The PCBA included in this kit is only compatible with the included flat end cutter guard.	P1058930-092	1
2	Cover for the Cutter includes PCBA and cutter cable ZT410. This item is only for replacing cutter PCBA part number P1059429-11 or cutter cover part number P1053981-10. The PCBA included in this kit is only compatible with the included flat end cutter guard.	P1058930-102	1
2	Cover for the Cutter includes PCBA and cutter cable ZT420. This item is only for replacing cutter PCBA part number P1059429-11 or cutter cover part number P1057226-11. The PCBA included in this kit is only compatible with the included flat end cutter guard.	P1058930-103	1
3	Replacement Static Brush & Cutter Guard with the Angled End Sensor Flag (old design) ZT410. Order this replacement item if the printer currently has an Angled End cutter guard installed.	79864M	1
3	Replacement Static Brush & Cutter Guard with the Angled End Sensor Flag (old design) ZT420. Order this replacement item if the printer currently has an Angled End cutter guard installed.	79865M	1
4	Replacement Static Brush & Cutter Guard with the Flat End Sensor Flag (new design) ZT410. Order this replacement item if the printer currently has a Flat End cutter guard installed.	P1066612	1
4	Replacement Static Brush & Cutter Guard with the Flat End Sensor Flag (new design) ZT420. Order this replacement item if the printer currently has a Flat End cutter guard installed.	P1066613	1

Peel & Liner Take-Up Replacement Parts

Peel Replacement Parts

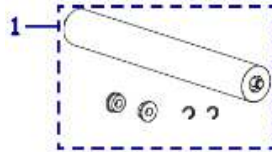

Item Number	Description	Part Number	Quantity
1	Roller for the Peel Assembly ZT410	77197M	1
1	Roller for the Peel Assembly ZT420	77727M	1

Liner Take-Up (LTU) Replacement Parts

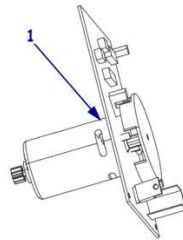

Item Number	Description	Part Number	Quantity
1	Motor and PCBA for Liner Take Up Spindle ZT410	G34112M	1

Media Rewind Replacement Parts

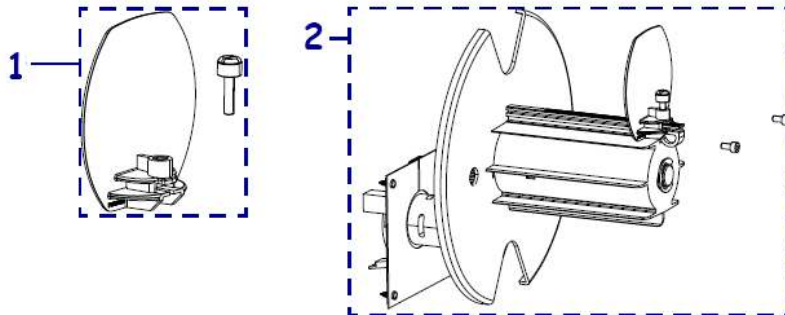

Item Number	Description	Part Number	Quantity
1	Media Guard for Media Rewind Spindle ZT400 Series	P1058930-057	1
2	Media Rewind Spindle (includes Motor and PCBA) ZT410 (This item is only for replacing an existing media rewind spindle on a printer that shipped from the factory with the media rewind option installed. Media rewind is not a field installable option)	P1058930-058	1
2	Media Rewind Spindle (includes Motor and PCBA) ZT420 (This item is only for replacing an existing media rewind spindle on a printer that shipped from the factory with the media rewind option installed. Media rewind is not a field installable option)	P1058930-059	1
	Motor and PCBA for Media Rewind Spindle ZT410	G34110M	1
	Motor and PCBA for Media Rewind Spindle ZT420	G34111M	1
	Steer Roller for Media Rewind ZT410	P1058930-055	1
	Steer Roller for Media Rewind ZT420	P1058930-056	1
	Door and Trim for Media Rewind ZT410	P1058930-060	1
	Door and Trim for Media Rewind ZT420	P1058930-061	1

Covers & Miscellaneous Hardware

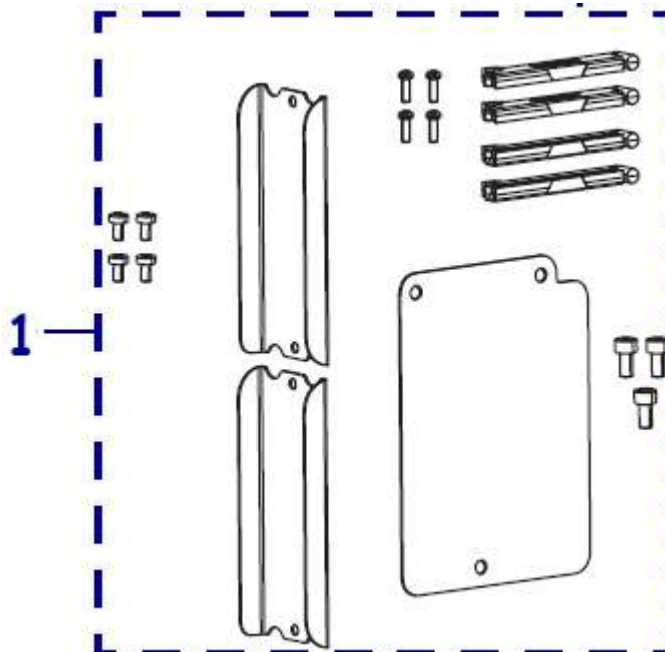

Item Number	Description	Part Number	Quantity
1	Covers/Mounts for Options ZT400 Series	P1058930-062	1
	Assorted Hardware ZT400 Series (various screws and washers used throughout the printer)	P1058930-065	1
	Feet on bottom of printer (Qty 20) ZT400 Series	P1058930-078	20

Packaging Materials for Printer Shipping

Item Number	Description	Part Number	Quantity
	Packaging for ZT410 (Qty 1)	P1058930-166	1
	Packaging for ZT410 (Qty 8)	P1058930-167	8
	Packaging for Media Rewind Versions of ZT410 (Qty 1)	P1058930-070	1
	Packaging for ZT420 (Qty 1)	P1058930-068	1
	Packaging for ZT420 (Qty 8)	P1058930-069	8
	Packaging for Media Rewind Versions of ZT420 (Qty 1)	P1058930-071	1