

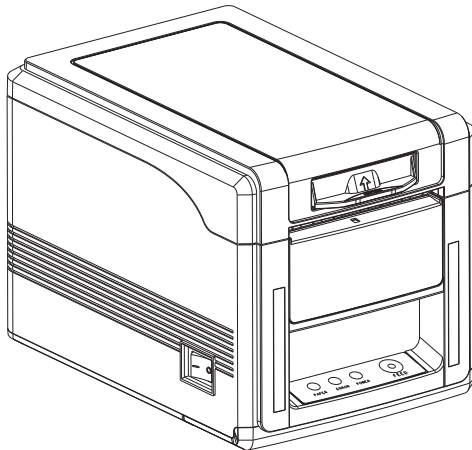

# **User Manual**

## **EC-PM-80340**

### **THERMAL RECEIPT PRINTER**



## 1. Safety Notice:

- \* Install the printer on stable place, choose a firm, level surface where avoid vibration.
- \* Do not use and store the printer under high temperature, humid or seriously polluted environment.
- \* Connect AC power adapter to a proper power outlet. Avoid to use the same outlet with other large electric machines which generate voltage fluctuation.
- \* Do not let water or conducting material (eg. metal) into the printer.
- \* Do not print when it is out of paper, which will seriously damage the printer head and rubber roller.
- \* We recommend that you unplug the printer from the power outlet whenever you do not plan to use it for a long period.
- \* Do not try to disassemble, repair or remodel the printer by yourself.
- \* Only use the power supply that is come along with the printer.
- \* We recommend that you use good paper to deliever high quality receipts and to ensure the printer's lifespan.
- \* Make sure that printer is off when connecting or disconnecting the plug, always hold the plug - notthe cord.
- \* Please keep this manual for your reference.

## 2. Applications:

- \* POS system Receipts
- \* EFT POS system Receipts
- \* Gym, post, hospital, civil aviation system Receipts
- \* Inquiry, Service system Receipts
- \* Instrument test Receipts
- \* Tax, Tab Receipts

## 3. Unpacking

After unpacking the unit, check that all the necessary accessories are included in the package.

<b>CD Disk</b>	1 PC
<b>Printer</b>	1 PC
<b>Serial interface cable</b>	1 PC
<b>Power Adapter (include power cord)</b>	1 SET
<b>Warranty Sheet</b>	1 PC

#### 4. Features

- \* 300mm/sec high printing speed
- \* Support 2D barcode printing
- \* Support kitchen printing and network printing
- \* Support front paper dispensing and auto cutter, stopping paper from jamming
- \* Support bar code printing
- \* Ports:Serial+USB+Ethernet ; USB+Wifi ; USB+Bluetooth
- \* 83mm Large Paper Roll Capacity
- \* Rational construction, easy maintenance
- \* Built in data buffer which can receive new task when printing is in progress
- \* Characters can be enlarged, bonded, underlined, line space and character space can be adjusted
- \* Support different density NV logo and download printing
- \* Low power consumption and low operation cost
- \* Compatible with EPSON ESC/POS and Star command sets
- \* Character and columns per line are optional by using DIP switches
- \* Support print status monitoring, multilink print, OPOS driver
- \* Support printer identification, software bundle, high speed driver printing mode
- \* Support various international characters

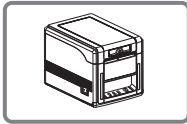

**Front Paper Exit**



**High Speed Printing**



**Bar Code Printing**

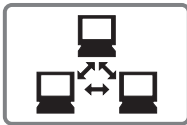

**Network Printing**



**OPOS Driver**

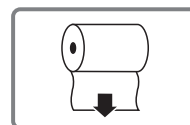

**120mm Large Roll**

## 5.Specification

<b>Model</b>	<b>EC-80340</b>
<b>Printing speed</b>	300mm/sec
<b>Paper roll</b>	<b>Paper Width:</b> 43/58/70/80/82mm <b>Paper Diameter:</b> 83mm max. <b>Roller diameter:</b> Inside: 12mm Outside: 18~26mm
<b>Dot density</b>	512/576 dots/line
<b>Character size</b>	ANK Character, <b>Font A:</b> 12×24dots, <b>Font B:</b> 9×17dots, <b>Chinese Character:</b> 24×24dots
<b>Print command</b>	Compatible with EPSON ESC/POS and Star command sets
<b>Interface</b>	Serial+Ethernet+USB ; USB+Wifi ; USB+Bluetooth
<b>Auto cutter</b>	Partial
<b>Reliability</b>	150Km
<b>Barcode mode</b>	UPC-A/UPC-E/JAN13(EAN13)/JAN8(EAN8)/CODE39/ ITF/CODABAR/CODE93/CODE128/QRCODE/PDF417
<b>Paper thickness</b>	0.06~0.08mm
<b>Powersupply</b>	DC 24V/2A
<b>Power adapter</b>	<b>Input:</b> AC110V~220V, 50~60HZ <b>Output:</b> DC 24V/2A
<b>Cash drawer</b>	DC 24V/1A
<b>Work environment</b>	<b>Temperature:</b> 0~45℃, <b>Dampness:</b> 10~80%
<b>Storage environment</b>	<b>Temperature:</b> -10~60℃, <b>Dampness:</b> 10~90%
<b>Dimension</b>	156×217×160mm(W×D×H)

## 6. Printer Connection

- a. Plug the power adapter cable into the printer's power port.
- b. Plug the interface cable securely into the printer's Serial/USB/Ethernet port.
- c. Plug the cash drawer's RJ-11 phone jack into the printer RJ-11 socket.

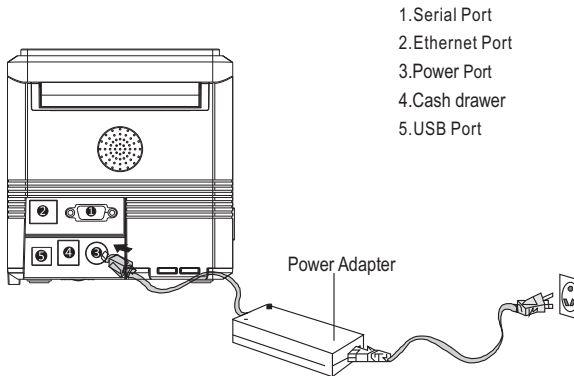

## 7. Paper Installation

- a. Press the button to open the printer cover.
- b. Put the paper roll into the hollow ( pay attention to the paper direction).
- c. Pull the leading edge of the roll outside of the printer and then close the cover.
- d. Press the center of printer cover firmly to prevent paper misloading, then tear off the paper outside.

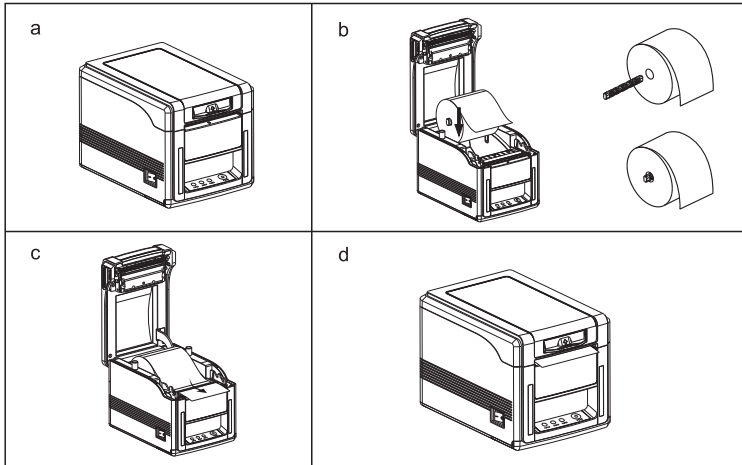

### 8. Print Mode Setting (DIP switches)

Users can select the auto cutter, language, printing speed, beep, print density by using DIP switches to set the printer.

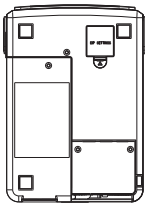

1. Remove the DIP switches cover on the bottom of the printer.

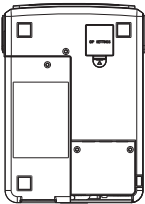
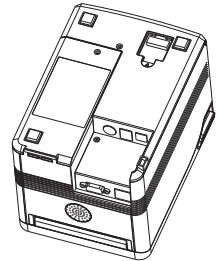

2. DIP switches setting.

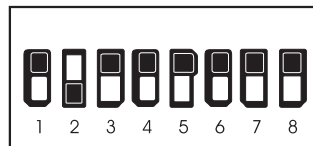
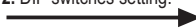

## 9. Three-view Drawing



Top view

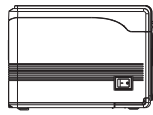

Side view

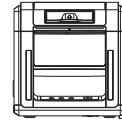

Front view

## 10. Cutter Maintenance

If step 1 failed, follow the below instructions

I. Open the printer cover as showing

III. Press the "FEED" again, cutter will return to its home position.

**⚠ Attention:** Do not use force to separate the printer cover in case of any damage to the print head and auto cutter.

## 11. Button and Indicators

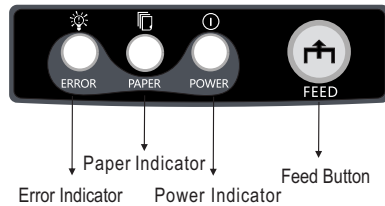

## 12. Function of button and indicators

### (1) ERROR Indicator

ON may indicate paper out, cutter error, print head overheated.  
OFF indicates normal status

### (2) PAPER Indicator

PAPER & ERROR are both ON, indicating printer is out of paper;  
PAPER & ERROR are both OFF, indicating printer is in normal status.

### (3) POWER Indicator

ON indicates printer power is on  
OFF indicates printer power is off.

### (4) FEED Button

Press the FEED button to feed the paper roll.



### 13. Professional Performance

- a. 300mm/sec high printing speed
- b. Support front paper exit and auto cutter
- c. Support bar code printing
- d. 83mm large roll paper
- e. Support various paper width printing

**Manufacturer: EC LINE**

Thank you very much for using EC Line product  
For service, please contact [service@ecline.com.hk](mailto:service@ecline.com.hk)

[www.eclinepos.com](http://www.eclinepos.com)